

COXO®

PT Master

USER MANUAL

Dental Scaler and Air Polisher



Foshan COXO Medical Instrument Co.,Ltd

No. 17, Guangming Ave., New Light Source Industrial Base,
Nanhai National High-tech Zone, Foshan 528226,
Guangdong P.R. China

Ver:1.1 Date:20230401

<https://www.alandental.com>

CONTENTS

1. Safety	1
2. Standard configuration.....	3
3. Intended use.....	5
4. Contraindications	5
5. Description.	6
6. Installation	7
6.1. Air hos and water tube.....	7
6.2. Pedal	7
6.3. Irrigation bottle	7
6.4. Powder Chamber.....	8
6.5. Powder handpiece.....	8
6.6. Ultrasonic handpiece	9
6.7. Adapter	9
7. Settings	10
7.1. Sound.....	10
7.2. Brightness	10
7.3. Pedal pairing	10
7.4. Software version.....	10
8. Blasting system.....	11
8.1. System selection.....	11
8.2. Mode selection.....	11
8.3. Power adjustment.....	11
8.4. Irrigation mode selection and volume adjustment.....	11
8.2. Heating.....	11
8.2. Working.....	11
9. Ultrasonic system.....	13

9.1. System selection	13
9.2. Mode selection	13
9.3. Power adjustment.....	13
9.4. Irrigation volume adjustment.....	13
9.5. Working	13
10. Auto-Cleaning.....	14
11. Cleaning,disinfection and sterilization.....	15
12. Maintenance	17
12.1. Replace filter cartridge.....	17
12.2. Replace water filter	17
12.3. Replace LED light.....	18
12.4. Unblocking	18
12.5. Replace spare O-ring.....	18
13. Troubleshooting	19
14. Operating,transport and storage environment	20
15. Technical specifications	20
16. Symbols	21
17. After-sales service.....	21
18. Recycling and disposal of waste.....	22
19. Guidance and manufacturer's declaration--EMC.....	22

NOTE 1 At 80 MHz and 800 MHz, the higher frequency range applies.
 NOTE2 These guidelines may not apply in all situations. Electromagnetic propagation is affected by absorption and reflection from structures, objects and people.

field strengths from fixed transmitters, such as base stations for radio (cellular/cordless) telephones and land mobile radios, amateur radio, AM and FM radio broadcast and TV broadcast cannot be predicted theoretically with accuracy. To assess the electromagnetic environment due to fixed RF transmitters, an electromagnetic site survey should be considered. If the measured field strength in the location in which the instrument is used exceeds the applicable RF compliance level above, the instrument should be observed to verify normal operation. If abnormal performance is observed, additional measures may be necessary, such as re-orienting or relocating the instrument.
 b Over the frequency range 150 kHz to 80 MHz, field strengths should be less than 3V/m.

Recommended separation distances between portable and mobile RF communications equipment and the instrument

The instrument is intended for use in an electromagnetic environment in which radiated RF disturbances are controlled. The customer or the user of the instrument can help prevent electromagnetic interference by maintaining a minimum distance between portable and mobile RF communications equipment (transmitters) and the instrument as recommended below, according to the maximum output power of the communications equipment.

Rated maximum output power of transmitter (W)	Separation distance according to frequency of transmitter		
	150 kHz to 80 MHz $d=1.2 \times \sqrt{P}$	80 MHz to 800 MHz $d=1.2 \times \sqrt{P}$	80 MHz to 800 MHz $d=2.3 \times \sqrt{P}$
0.01	0.12	0.12	0.23
0.1	0.38	0.38	0.73
1	1.2	1.2	2.3
10	3.8	3.8	7.3
100	12	12	23

For transmitters rated at a maximum output power not listed above, the recommended separation distance d in meters (m) can be estimated using the equation applicable to the frequency of the transmitter, where P is the maximum output power rating of the transmitter in watts (W) according to the transmitter manufacturer.

NOTE1: At 80 MHz and 800 MHz, the separation distance for the higher frequency range applies.
 NOTE2: These guidelines may not apply in all situations. Electromagnetic propagation is affected by absorption and reflection from structures, objects and people.

Guidance and manufacture's declaration- electromagnetic immunity			
The instrument is intended for use in the electromagnetic environment specified below. The customer or the user of instrument should assure that it is used in such an environment.			
Immunity test	IEC 60601 test level	Compliance level	Electromagnetic environment-guidance
Electrostatic discharge (ESD) IEC 61000-4-2	±8 kV contact ±2 kV, ±4 kV, ±8kV, ±15 kV air	±8 kV contact ±2 kV, ±4 kV, ±8kV, ±15 kV air	Floors should be wood, concrete or ceramic tile. If floor are covered with synthetic material, the relative humidity should be at least 30%.
Electrical fast transient/burst IEC 61000-4-4	±2kV for power supply lines ±1 kV for Input/output lines	±2kV for power supply lines ±1 kV for Input/output lines	Mains power quality should be that of atypical commercial or hospital environment.
Surge IEC 61000-4-5	±0.5 kV & ±1 kV differential mode ±0.5 kV, ±1 kV & ±2 kV common mode	±0.5 kV & ±1 kV differential mode ±0.5 kV, ±1 kV & ±2 kV common mode	Mains power quality should be that of a typical commercial or hospital environment.
Voltage dips, short interruptions and voltage variations on power supply input lines IEC 61000-4-11	100 % U _r (100% dip in U _r) for 0.5 cycle 100 % U _r (100% dip in U _r) for 1 cycle 30 % U _r (70% dip in U _r) for 25/30 cycles 100 % U _r (100% dip in U _r) for 250/300 cycle	100 % U _r (100% dip in U _r) for 0.5 cycle 100 % U _r (100% dip in U _r) for 1 cycle 30 % U _r (70% dip in U _r) for 25/30 cycles 100 % U _r (100% dip in U _r) for 250/300 cycle	Mains power quality should be that of a typical commercial or hospital environment. If the user of the instrument requires continued operation during power mains interruptions, it is recommended that the instrument be powered from a unit erupible power supply or a battery.
Power frequency (50/60 Hz) magnetic field IEC 61000-4-8	3A/m	3A/m	Power frequency magnetic fields should be at levels characteristic of a typical location in a typical commercial or hospital environment.

NOTE: U_r is the a.c. mains voltage prior to application of the test level.

Guidance and manufacture's declaration- electromagnetic immunity			
The instrument is intended for use in the electromagnetic environment specified below. The customer or the user of instrument should assure that it is used in such an environment.			
Immunity test	IEC 60601 test level	Compliance level	Electromagnetic environment-guidance
Conducted RF IEC 61000-4-6	3 Vrms 150 kHz to 80 MHz 6 Vrms in ISM and amateur radio bands 3 V/m 80 MHz to 2.7 GHz	3 Vrms 150 kHz to 80 MHz 6 Vrms in ISM bands 3 V/m 80 MHz to 2.7 GHz	Portable and mobile RF communications equipment should be used no closer to any part of the instrument, including cables, than the recommended separation distance calculated from the equation applicable to the frequency of the transmitter. Recommended separation distance $d=1.2 \times \sqrt{P}$ $d=1.2 \times \sqrt{P}$ 80 MHz to 800 MHz $d=1.2 \times \sqrt{P}$ 800 MHz to 2.5 GHz where is the maximum output power rating of the transmitter in watts (W) according to the transmitter manufacturer and d is the recommended separation distance in meters (m). Field strengths from fixed RF transmitters, as determined by an electromagnetic site survey, "should be less than the compliance level in each frequency range." Interference may occur in the vicinity of equipment marked with the following symbol:
Radiated RF IEC 61000-4-3	385MHz-5785MHz Test specifications for ENCLOSURE PORT IMMUNITY to RF wireless communication equipment (Refer to table 9 of IEC 60601-1-2:2014)	385MHz-5785MHz Test specifications for ENCLOSURE PORT IMMUNITY to RF wireless communication equipment (Refer to table 9 of IEC 60601-1-2:2014)	



1. Safety



Carefully read this manual before proceeding with the installation, use, maintenance, or other operations on the device. Always keep this manual within reach.

- 1) Do not handle the power cord with wet hands. Wet hand contact with electricity may result in an electric shock.
- 2) Keep away from explosive substances and flammable materials.
- 3) If the product overheats or smells of burning, immediately turn off the power and disconnect the main power cord.
- 4) Be careful not to get water or liquid disinfectant in the Control Unit. This could cause short circuits and lead to fire and/or electric shock.
- 5) Connect to a public water system that provides drinkable water at a water pressure between 0.1 and 0.3 MPa. Using with an incorrect water pressure may result in insufficient water supply, inoperability, or malfunction.
- 6) Always use the water supply. Insufficient water supply results in overheating, which may damage the surface of the patient's tooth.
- 7) During use, both the operator and the assistant should always wear protective glasses and protective face masks. Also, continuously vacuum and collect ejected powder during use. If any powder gets into the eyes, eyes wash out immediately with copious amount of water and consult an ophthalmologist.
- 8) Set the supply air pressure to 0.55 - 0.75 MPa and use clean, dry air. Using with the incorrect pressure may result in insufficient spray pressure (power), inoperability or malfunction.
- 9) Do not spray directly onto the cement in the root canal, decalcified enamel, filling, margin of a prosthesis or filling.
- 10) Make sure the compressed air supply is clean and dry. Water or oil content mixed in the air supply may cause solidification of the cleaning powder inside the product.
- 11) The device must be used within the scope mentioned in this manual. If the user fails to operate the device in accordance with the manual or uses the device for other purposes, the Company or the authorized Distributor shall not be liable.
- 12) The use of the device is restricted to qualified medical and technical personnel and trained professionals.
- 13) Do not make any modifications to this device.
- 14) Use the original parts and contact the manufacturer or authorized dealer for purchase and replacement if the parts are damaged.
- 15) Please check the integrity of the nozzle and the tightness of the package. Do not use it if it is damaged.
- 16) Keep the device clean before and after use.
- 17) Allow the device to run under water for 10 seconds before each operation to remove residual water in the pipe.

- 18) The Ultrasonic Tips must be tightened during use. When the Ultrasonic Tips is damaged or worn, the vibration intensity will decrease. The user should replace the Ultrasonic Tips in time.
- 19) Do not bend or polish the Ultrasonic Tips.
- 20) Be very careful to ensure cleaning powder does not enter the patient's mucosal areas (eyes, nose, etc.) other than the oral cavity. Also, protect the face with a towel or protective glasses, etc., to prevent the cleaning powder from getting into the patient's eyes.
- 21) Before connecting the Handpiece cord, Chamber and Handpiece, be sure to blow off all water from the connections with dry air. Failure to do so may result in moisture entering the air supply, causing solidification of the cleaning powder inside the product.
- 22) Do not use unclean water sources.
- 23) Do not pull hard on the handpiece cord to avoid damage.
- 24) Do not knock or scratch the handpiece.
- 25) The device has electromagnetic interference and should not be used in the vicinity of a pacemaker or electronic surgery.
- 26) Both electromagnetic fields and unstable voltages can interfere with the normal operation of the device.
- 27) In order to avoid electric shock injury, the device must be connected to the power supply network with protective ground.
- 28) The device isn't intended used in areas such as emergency rooms of operating theatres.
- 29) Time to contact unit enclosure, power supply cord, power switch, rotary knob, screen, foot pedal, adapter and applied part is less than 1min.

18. Recycling and disposal of waste



The device and its packaging are designed to be as environmentally friendly as possible.

In accordance with the principles, standards, and requirements of the country (region) in which you are located. When disposing of the old electrical instrument ensure that pollution is not produced in the process of waste disposal.

19. Guidance and manufacturer's declaration -- EMC

This instrument needs special precautions regarding EMC and needs to be installed and put into service according to the EMC information provided, and this instrument can be affected by portable and mobile RF communications instrument.



Warning

Do not use a mobile phone or other instruments that emit electromagnetic fields, near the instrument. This may result in incorrect operation of the instrument.

This instrument has been thoroughly tested and inspected to assure proper performance and operation!

This instrument should not be used adjacent to or stacked with other instrument and that if adjacent or stacked use is necessary, this instrument should be observed to verify normal operation in the configuration in which it will be used.





















Number	Name	Length (m)	Shielding
1	Power cord	1.5	No
2	Adapter cable	1.5	No
3	Handpiece cord	1.8	No
4	Wired pedal cable	1.8	No

Guidance and manufacture's declaration – electromagnetic emission

The instrument is intended for use in the electromagnetic environment specified below. The customer or the user of the instrument should assure that it is used in such an environment.

Emission test	Compliance	Electromagnetic environment – guidance
RF emissions CISPR 11	Group 1	The instrument use RF energy only for its internal function. Therefore, its RF emissions are very low and are not likely to cause any interference in nearby electronic equipment.
RF emission CISPR 11	Class B	The instrument is suitable for use in all establishments, including domestic establishments directly connected to the public low-voltage power supply network with specific requirement.
Harmonic emissions IEC 61000-3-2	Class A	
Voltage fluctuations/flicker emissions IEC 61000-3-3	Complies	

16. Symbols

	Warning		Follow instructions for use
	Note		Thermoisinfectable
	Type B applied part		Fragile, handle with care
	Keep dry		Sterilizable in a steam sterilizer at 134°C
	Vertical up		Indoor use
	Direct current		Serial number
	Manufacturer		Date of Manufacture
	Medical device		Authorized representative in the European Community
	Special disposal of waste electrical and electronic equipment		Alternating current
	CE mark		Catalogue number
	Batch code		

17. After-sales service

- 1) The control unit and handpiece are guaranteed for 24 months from the date of purchase, and the accessories (adapter) are guaranteed for 6 months. The rest of the accessories are not guaranteed.
- 2) The following conditions are not covered by the free warranty:
 - Damage caused by human causes;
 - Force majeure causes damage;
 - User's unauthorized alteration, dismantling or maintenance;
 - Any damage caused by not using and maintaining according to the instructions;
 - Failure or damage caused by forced use of the product beyond the normal conditions of use.
- 3) The supplier can provide, upon request, circuit diagrams, component lists, notes, calibration specifications, or other information necessary to assist the user's qualified technicians in the repair of parts of the equipment which are designated as repairable by the manufacturer.

2. Standard configuration

Before the first using, please check the accessories; make sure they are all in good condition.

Name	Number
Control Unit	1
Powder Handpiece (for Prophy use)	1
Powder Handpiece (for Perio use)	1
Ultrasonic Handpiece	1
Foot Pedal	1
Power cord	1
Adapter	1
Powder Chamber (Black for Prophy use, orange for Perio use)	2
Irrigation Bottle	1
Ultrasonic Tip (G4*2, P52*2, P56*2, P3*2, P59*2, P50L*2, P50R*2, CU*2, P90*1)	17
Notice: The 9 types of ultrasonic tips are standard configuration, which are repair parts, not attach with CE marks separately for sales.	
Nozzle (for Perio use)	20
Water Tube	1
Air Hose	1

Three-way Unit	6
Torque Wrench	1
Air Filter	1
Water Filter	2
Spanner Wrench (for nozzle)	1
Spanner Wrench (for air filter)	1
Unlocking Tool	2
Spare O-Ring	17
LED Light Set	2
User Manual	1



Note

1)The nozzles supplied with this product are manufactured by EMS Electro Medical Systems SA and are available for purchase on its official website: www.ems-dental.com

2)Ultrasonic Tip can be CE certified separately, users can buy the Ultrasonic Tip in the market that conforms to CE certification. Recommended to buy Ultrasonic Tip manufactured by EMS Electro Medical Systems SA.

14. Operating, transport and storage environment

Operating environment

Ambient temperature	+5°C-40 °C
Relative humidity	20%RH-80%RH
Air pressure	80kPa-106kPa
ALT	≤2000m

Transport and storage environment

Ambient temperature	-10°C-55 °C
Relative humidity	≤93% RH
Air pressure	50kPa-106kPa

15. Technical specifications

Adapter	Input: AC100-240V50/60Hz
	Output: DC30V, 2.4A
Input power	80VA
Operating mode	Continuous operation
Degree of Protection(IEC 60529)	Control unit (IPX1)
	Foot pedal (IPX4)
Classified by how safe it is to use in the case of flammable anesthetic gas mixed with air or nitrous oxide	Non-AP/APG type
Application part	Handpiece: aluminium (6063) Ultrasonic Tip: stainless steel (304)
Protection against electric shock	Type B
Classification of protection against electric shock	Class I (Adapter)
Ultrasonic Tips vibration offset	< 200µm
Ultrasonic Tips vibration frequency	24-36 kHz
Half offset force	≥ 0.5 N
Ultrasonic Tips output power	0.8-13 w
Input pressure	0.55-0.7 Mpa
Weight	3kg
Control unit size	L×W×H: 30cm×26cm×13cm
Overvoltage category	Class II
Pollution Degree	Degree 2

13. Troubleshooting

Malfunction	Cause	Remedy
Non-functional device	Power cord not plugged in properly	Check the power plug
	The power switch is not turned on	Turn on the power
The pedal doesn't work when press it	Bad contact of wired pedal	Reconnect
Air/water leakage of handpiece	The spare O-ring is damaged	Replace the O-rings
Ultrasonic handpiece overheating	Insufficient coolant	Increase irrigation volume
The ultrasonic handpiece LED light is not on	LED light damage	Replace LED lights
Abnormal working of the Ultrasonic Tips (such as reduced vibration, no water coming out, etc.)	The Ultrasonic Tips is loose	Tighten it with torque wrench
	The Ultrasonic Tips is damaged	Replace with a new one
	Blocked waterways cause tips not to come out of the water	Unblocking with three guns
Low efficiency of blasting	Insufficient powder	Increase the power
	Powder handpiece is blocked	Clean and blow it with compressed air
	Nozzle is blocked	Replace nozzle
	Powder chamber is blocked	Unblocking with unlocking tool
	Powder absorbs moisture and clumps	Replace with a new powder
Air leakage of powder chamber	There is powder residue at the mouth or cap thread or the thread is not screwed in place	Clean the remaining powder and blow dry with compressed air
Irrigation bottle leaks	The spare O-ring is damaged	Replace O-ring
Device appears abnormal noise	Pressure is too low, not within the required range	Increase the pressure to 0.55-0.7Mpa

3. Intended use

Tooth surface cleaning, removal of plaque or calculus, tooth resection, expansion or cleaning of root canal, removal of foreign substances, root canal obturation, enhancing adhesion of fixed restorations, incision or removal of periodontal tissue;
This device is only used in dental clinics or hospitals.

4. Contraindications

Do not use on the following patients:

- Users who have pacemakers (or other electrical equipment) and are warned not to use small appliances (such as electric razors, hair dryers, etc.)
- Hemophilia patients;
- pregnant women, children, photoallergies and patients with retinal history;
- Patients with respiratory diseases such as asthma and chronic bronchitis;
- Those who have preexisting conditions (E.g. Cardiac, Pulmonary, Renal disturbance or High blood pressure)

5. Description

Front

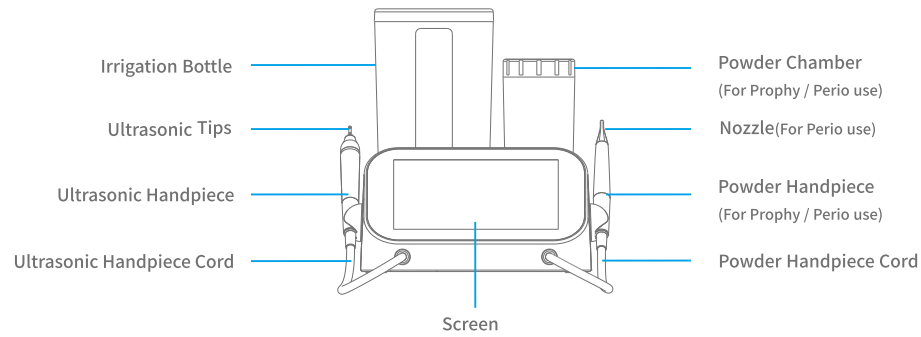

Rear

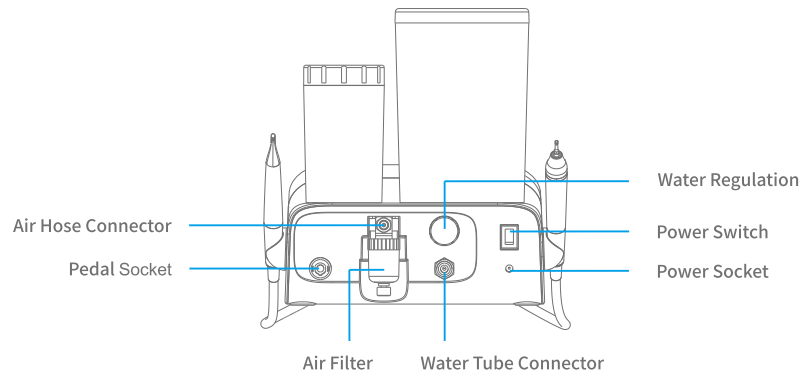

Foot Pedal

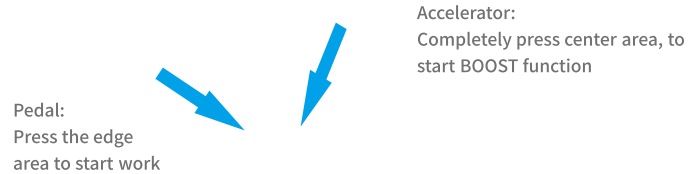

12.3 Replace LED light

- Turn the handpiece cap counterclockwise;
- Pull out the lamp bead, replace it and tighten the handpiece cap.

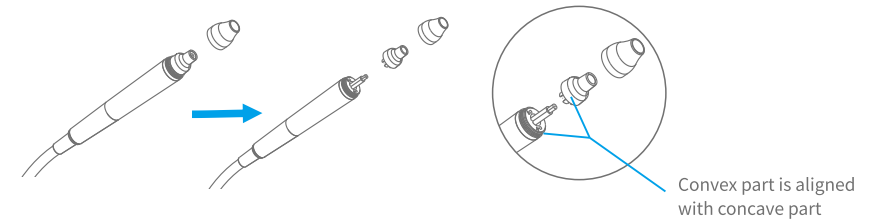

12.4 Unblocking

Insert the unlocking tool into the blocked part and rotate it around, bring out the blockage, and finally blow it clean with compressed air.

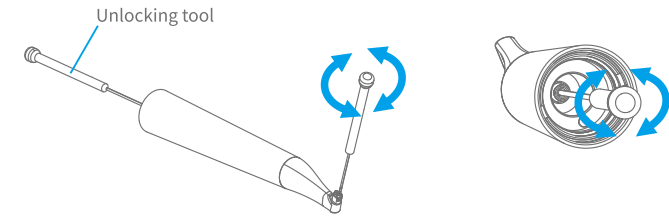

i Note

To avoid clogging, use clean water and keep the sand powder dry.

12.5 Replace spare O-ring

When there is water leakage in the handpiece and air leakage in the air filter, check the O-ring in time. If damaged, replace it in time.

12. Maintenance

The following maintenance of this product may be performed by a qualified physician or nurse practitioner.

12.1 Replace Air filter

Air filter is mainly used to remove dirt, rust slag, dust, oil, moisture in the air. It is recommended to replace once every 24 months.

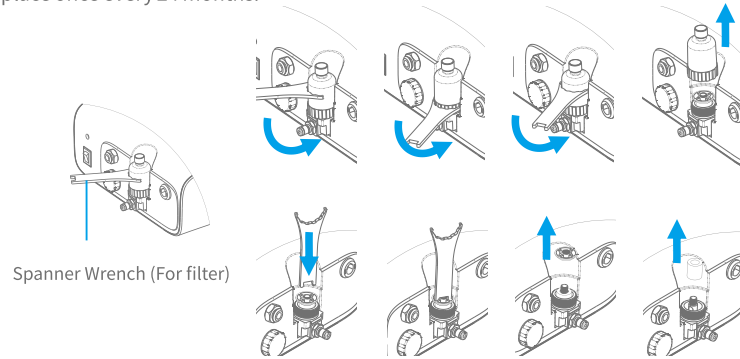

12.2 Replace water filter

Water filters are mainly used to remove suspended matter, chlorine, organic impurities, color, odor, etc. to avoid device failure. If external water is used frequently, it is recommended to check the filter monthly and replace it if it is found to be very dirty.

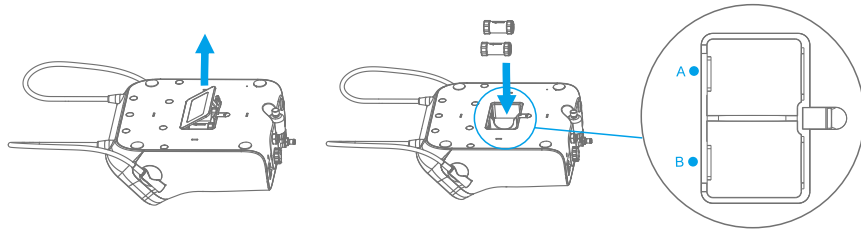

i Note

It is recommended that the water filter in the primary filtration bin (position A) be replaced every 12 months and the water filter in the secondary filtration bin (position B).

! Warning

Be sure to install water filters before use!

6. Installation

! Warning

- If any parts are damaged, it is recommended to buy the original parts.
- Please do not position the device to make it difficult to operate the disconnection device.

6.1 Air hose and water tube

Insert one end of the air hose / water tube to the control unit and the other end to the air / water source.

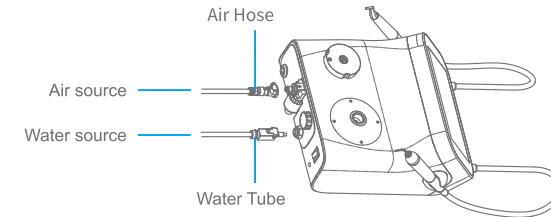

i Note

- Input pressure range is required to be 5.5bar-7.0bar (0.55 MPa-0.7 MPa);
- Input water pressure range is required to be 1.0bar-3.0bar (0.1MPa-0.3 MPa).

6.2 Pedal

Align the marker points to connect the pedal with the device.

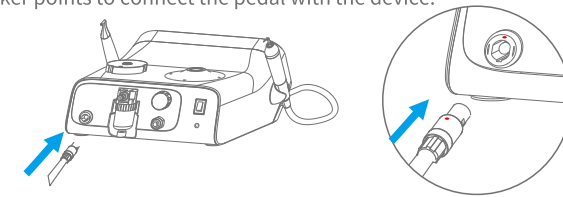

6.3 Irrigation bottle

Insert the irrigation bottle containing water directly into the bottle interface.

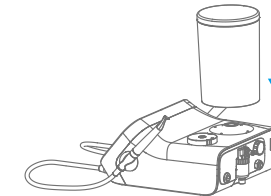

6.4 Powder Chamber

- Connection: First, the arrow at the bottom of the powder chamber is directed at the triangular icon of the control unit and then directly inserted.
- Disconnection: After pressure relief, pull it upward.

i Note

Do not exceed the maximum scale of irrigation bottle.

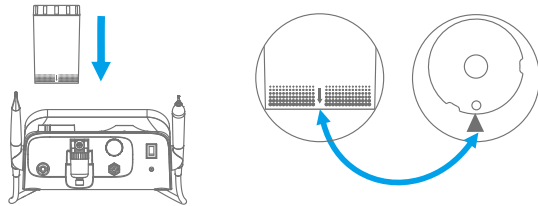

i Note

- The amount of powder should be controlled between MIN and MAX;
- Please keep the powder chamber and powder dry;
- Do not remove or open the powder chamber when it is under pressure;
- In Blasting system, the device will automatically identify the type of powder chamber and display it in the status bar at the top of screen:



Supragingival

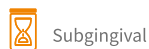

Subgingival



Undetected

6.5 Powder handpiece

6.5.1 Powder handpiece

- Use air to dry the connection between the Handpiece and Handpiece Hose Plug;
- Push the powder handpiece straight into the handpiece cord.

6.5.2 Nozzle (For Perio use)

- Connection: Insert handpiece head in the direction of nozzle "D" head;
- Disconnection: Use the spanner wrench to pry it out.

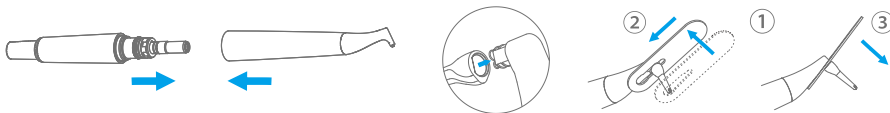

	free towel. Insufflate cavities of products by using sterile compressed air.
Functional Testing, Maintenance:	<p>Visual inspection for cleanliness of the products and reassembling, if required.</p> <p>All products should be checked again for dryness.</p> <p>After cleaning and disinfection, a thorough inspection and maintenance ensures that the products are fit for use.</p> <p>-Check that the product has no dents, cracks, deformations, scratches, etc.;</p> <p>-Check all markings on the product for clear visibility. Discard and replace any components as necessary.</p> <p>Do not use the device with following defects: material deformation, cracks on the product, brittle or other change in the material, etc.</p>
Packaging:	Pack the products in an appropriate packaging material for sterilization. The packaging material and system refer to EN ISO 11607.
Sterilization:	<p>Sterilization of products by applying a fractionated pre vacuum steam sterilization process (according to EN 285/EN ISO 17665) under consideration of the respective country requirements.</p> <p>Following sterilization parameters are commonly used: 134 °C, 5 min (standard program in EU)</p> <p>Drying time:</p> <p>For steam sterilization, we recommend a drying time of 20 to 40 minutes. Choose a suitable drying time, depending on the autoclave and load. Refer to the autoclave's instructions for use.</p> <p>After sterilization:</p> <ol style="list-style-type: none"> Remove the product from the autoclave. Let the product cool down at room temperature for at least 30 minutes. Do not use additional cooling. Check that the sterilization wraps or pouches are not damaged.
Storage:	Storage of sterilized instruments in a dry, clean and dust free environment at modest temperatures, refer to label and instructions for use.
Reprocessing validation study information:	<p>-Foshan COXO _Cleaning Disinfection Validation Report, Report No.: MDS-RECD-230809-222</p> <p>-Foshan COXO _Sterilization Validation Report, Report No.: MDS-RES-230809-223</p> <p>-Foshan COXO _Sterilization Validation Report, Report No.: MDS-RES-230809-224</p>

<p>Pre-Cleaning of Powder Handpiece, Ultrasonic handpiece, Ultrasonic tips, Spanner wrench, and Torque wrench:</p>	<p>Following instructions are only relevant for powder handpiece, ultrasonic handpiece, ultrasonic tips, spanner wrench, and torque wrench! Not use automated cleaning, disinfection and sterilisation for other parts than powder handpiece, ultrasonic handpiece, ultrasonic tips, spanner wrench, and torque wrench in this system! Do a manual pre-cleaning, until the instruments are visually clean. Submerge the instruments in a cleaning solution and flush the lumens with a water jet pistol with cold tap water for at least 10 seconds. Clean the surfaces with a soft bristle brush.</p>
<p>Cleaning:</p>	<p>Regarding cleaning/disinfection, rinsing and drying, it is to distinguish between manual and automated reprocessing methods. Preference is to be given to automated reprocessing methods, especially due to the better standardizing potential and industrial safety. Automated Cleaning: Use a washer-disinfector meeting the requirements of the EN ISO 15883 series. The products in the washer-disinfector are arranged in such a way that there is no rinsing shadow and the water drains off quickly. Start the program: •4 min pre-washing with cold water (<40°C); •emptying •5 min washing with a mild alkaline cleaner at 55°C •emptying •3 min neutralising with warm water (>40°C); •emptying •5 min intermediate rinsing with warm water (>40°C) •Emptying The automated cleaning processes have been validated by using 0.5% neodisher MediClean forte (Dr. Weigert). Note Acc. to EN ISO 17664 no manual reprocessing methods are required for these devices. If a manual reprocessing method has to be used, please validate it prior to use.</p>
<p>Disinfection:</p>	<p>Automated thermal disinfection in washer/disinfector under consideration of national requirements in regards to A0 value (see EN ISO 15883). A disinfection cycle of 5 min disinfection at 90°C has been validated for the device to achieve an A0 value of > 3000. Here we suggest a disinfection cycle of 5 min disinfection time at 93°C.</p>
<p>Drying:</p>	<p>Automated Drying: Drying the products through drying cycle of washer/disinfector. If needed, additional manual drying can be performed through lint</p>

6.6 Ultrasonic handpiece

6.6.1 Ultrasonic handpiece

- Connection: Align the dots on the ultrasonic handpiece and handpiece cord, then push handpiece straight into the connector;

Warning

- This product is non-sterile and needs to be disinfected with medical alcohol for 5 minutes before use;
- The nozzle is disposable and prohibited from secondary use.

- Disconnection: Hold the ultrasonic handpiece and handpiece cord, then pull the handpiece out.

6.6.2 Ultrasonic Tips

- Connection: Hold the handpiece and screw in the Ultrasonic Tips, and then insert it into the torque wrench, finally rotate clockwise.
- Disconnection: Hold the handpiece tightly, insert the Ultrasonic Tips into the torque wrench, and then rotate counterclockwise.

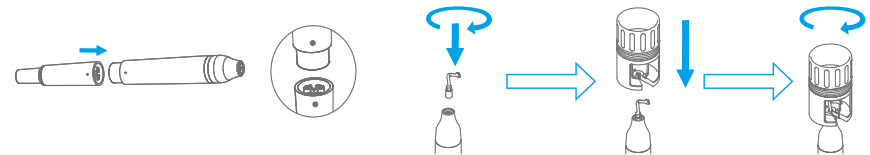

6.7 Adapter

Connect Power ③→②→①
 Connect the adapter to the device, then connect it to the net power.

Disconnect Power ①→②→③
 Disconnect the net power supply, then disconnect the adapter from the device.

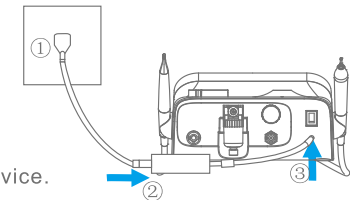

Note

Please be careful not to touch the appliance with wet hands.

7. Settings

Press to enter the settings and press to exit.

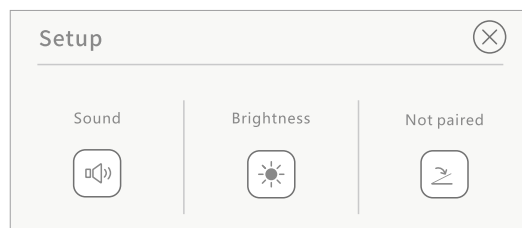

7.1 Sound

Press to turn on or off the sound;

: sound is on; : sound is off.

7.2 Brightness

Press to select the screen brightness.

7.3 Pedal pairing

- The icon at the top of screen shows the status of foot pedal:

(twinkle) No pedals is connected.

Wired pedals is connected.

7.4 Software version

PT Master: V1.0

11. Cleaning, disinfection and sterilization

Device:	Dental Scaler and Air Polisher The procedure for cleaning, disinfection and sterilization applies only to the accessories powder handpiece, ultrasonic handpiece, ultrasonic tips, spanner wrench, and torque wrench.
Advice:	Reprocessing procedures have only limited implications to this dental instrument. The limitation of the numbers of reprocessing procedures is therefore determined by the function / wear of the device. From the processing side there is no maximum number of allowed reprocessing. The device should no longer be reused in case of signs of material degradation. In case of damage the device should be reprocessed before sending back to the manufacturer for repair.
Reprocessing Instructions	
Preparation at the Point of Use:	Disconnect the handpiece and ultrasonic tips. Remove gross soiling from the device with cold water (<40°C) immediately after use, if applicable. Don't use a fixating detergent or hot water (>40°C) as this can cause the fixation of residuals which may influence the result of the reprocessing process.
Transportation:	Safely store the device in a humid surrounding and transport it to the reprocessing area to avoid any damage and contamination to the environment.
Preparation for Decontamination:	The devices must be reprocessed in a disassembled state, as far as possible. Only powder handpiece, ultrasonic handpiece, ultrasonic tips, spanner wrench, and torque wrench can be cleaned and disinfected with automated methods and sterilized with steam sterilization process. Do not sterilize the control unit. The control unit cannot be cleaned and disinfected in a washer/disinfector. For these parts, only a general wipe decontamination is possible!
Decontamination of other parts than Powder Handpiece, Ultrasonic handpiece, Ultrasonic tips, Spanner wrench, and Torque wrench:	After operation, take out the control unit on the workbench. Soak a soft cloth completely with distilled water or deionized water, and wipe all the surfaces of these components, until the surface of the components is visually clean. For decontamination, soak a dry soft cloth with 75% alcohol or other disinfects which are approved for its efficacy by VAH/DGHM-listing, CE marking, FDA and Health Canada Approval. Wipe all surfaces of control unit and other components with the wet soft cloth for about 3 minutes. Please follow the instructions of manufacturer of disinfectants. Wipe the surface of the component with a dry soft lint-free cloth.

10. Auto-Cleaning

- 1) Take the handpiece out of the handpiece holder. For the powder handpiece (for Perio use), remove the nozzle from the handpiece;
- 2) Place the tip of the handpiece into the container to catch water;
- 3) Press the  button and start auto-cleaning;
- 4) Auto-Cleaning takes about 30 seconds and can be cancelled at any time during the cleaning process.

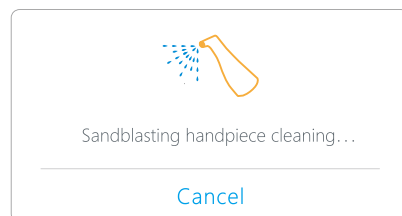
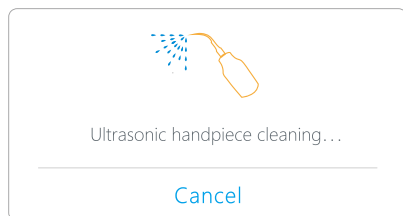

i Note

Ultrasonic handpiece and powder handpiece cannot be cleaned at the same time; Only bottle water supply can be used for auto-cleaning function.

8. Blasting system

8.1 System selection

- When taking down the powder handpiece from the handpiece holder, automatically enter the blasting system;
- you can also press **Piezo**  to switch when the handpieces are not taken down.

8.2 Mode selection

The system contains two modes: Prophy and Perio. Press any position in the following icon to switch modes.

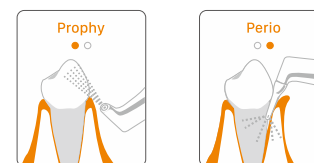

8.3 Power adjustment

Press the "+" or "-" on the right side of the  to adjust the power.

8.4 Irrigation mode selection and volume adjustment

Blasting system can use bottle or tap water, and press  to switch. The selected mode is displayed on the screen as an icon.



: Bottle water



: Tap water

8.4.1 Bottle water

Press "+" or "-" on the right side of the  to adjust the irrigation volume.

8.4.2 Tap water

Adjust irrigation volume through water adjust knob on the back of the control unit.

8.5 Heating

Press the  button to turn on/off the heating function.



Heating function is on



Heating function is off

8.6 Working

- 1) Press the pedal to start working, and release to stop;
- 2) Power level and irrigation volume can be adjusted during working;

- 3) Press the accelerator pedal hard to start BOOST function that can increase blasting power;
- 4) If the actual power is lower than the set value, the system will automatically detect.



8.6.1 Prophy mode

- 1) Before treatment, adjust the power level and the irrigation level before using on the patient;
- 2) Keep the nozzle at a distance of 3 - 5mm from the tooth surface and at an angle of 30 - 60 degrees.



8.6.2 Perio mode

- 1) Insert the nozzle tip deeper than 3mm into the periodontal pocket;
- 2) Keep the nozzle at a distance of 4 - 9mm from the tooth surface and moving at a vertical direction;

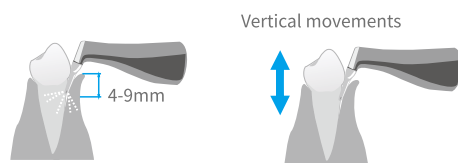

Note

- Powder may not be sprayed efficiently into the periodontal pocket if the depth is less than 3mm.
- Never point the nozzle directly toward the oral mucous membrane or in periodontal pockets.
- Users should wear a protective mask.

8.6.3 Releasing residual pressure

The chamber cap cannot be opened after operation due to buildup of air pressure inside the chamber increasing during operation. Release the pressure remaining in the chamber before putting powder in the chamber or removing the chamber from the control unit.

- 1) Take the powder handpiece out of the handpiece holder.
- 2) Place the handpiece into the container to catch powder and water.
- 3) Press the button and start to release.

9. Ultrasonic system

9.1 System selection

- When taking down the ultrasonic handpiece from the handpiece holder, automatically enter the ultrasonic system;
- you can also press **Blasting** to switch when the handpieces are not taken down.

9.2 Mode selection

The system contains four modes: Scaling, Perio, Endo and Irrigation. Press any position in the following icon to switch modes.

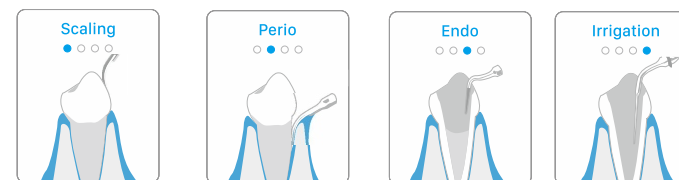

9.3 Power adjustment

Press the "+" or "-" on the right side of the to adjust the power.

9.4 Irrigation volume adjustment

- 1) Ultrasonic system may only use bottle water supply;
- 2) Press "+" or "-" on the right side of the to adjust the irrigation volume.

9.5 Working

- 1) Press the pedal to start working, and release to stop;
- 2) Power level and irrigation volume can be adjusted during working;
- 3) Press the accelerator pedal hard to start BOOST function that can increase ultrasonic power;



- 4) After the operation is complete, let the device run under water for 30 seconds to flush Ultrasonic Tips.